



# MINECRAFT

21254



LEGO® Builder



LEGO.com/sustainable-packaging



FR  
**DONNEZ**  
OU  
**RECYCLEZ**



OU



OU



ASSOCIATION

MAGASIN

DÉCHÈTERIE

Adresses sur [quefairedemesdechets.fr](http://quefairedemesdechets.fr)

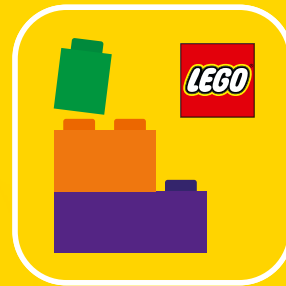

🔍 LEGO® Builder

# BUILDER

Download on the  
App Store

GET IT ON  
Google Play

腾讯应用宝  
安卓应用商店

Apple and the Apple logo are trademarks of Apple Inc., registered in the U.S. and other countries and regions. App Store is a service mark of Apple Inc. Google Play and the Google Play logo are trademarks of Google LLC. Tencent and the Tencent logo are trademarks of Tencent Inc.

🔍 [LEGO.com/devicecheck](https://LEGO.com/devicecheck)

EN Ask parents' permission before going online | DE Eltern um Erlaubnis bitten, bevor du online gehst | FR Demande l'autorisation d'un parent avant d'aller en ligne | IT Chiedi il permesso ai tuoi genitori prima di andare online | ES Pídeles permiso a tus papás antes de conectarte a Internet | PT Peça autorização aos pais antes de acederes online | ZH 上网前应先征得父母的同意 | PL Poproś rodziców o zgodę, zanim wejdiesz do Internetu | CS Než půjdeš na internet, požádej rodiče o svolení | SK Skôr než pôjdeš na internet, vypýtaj si povolenie od rodičov | HU Kérj szülői engedélyt, mielőtt online csatlakoznál! | RO Cere permisiunea părinților înainte de a te conecta online | BG Поискайте разрешение от родител, преди да влезете онлайн | LV Pirms došanās tiešsaistē palūdz atļauju vecākiem | ET Enne Interneti kasutamist küsi vanematelt luba | LT Prieš prisijungdami prie interneto, atsilkauskite tėvų

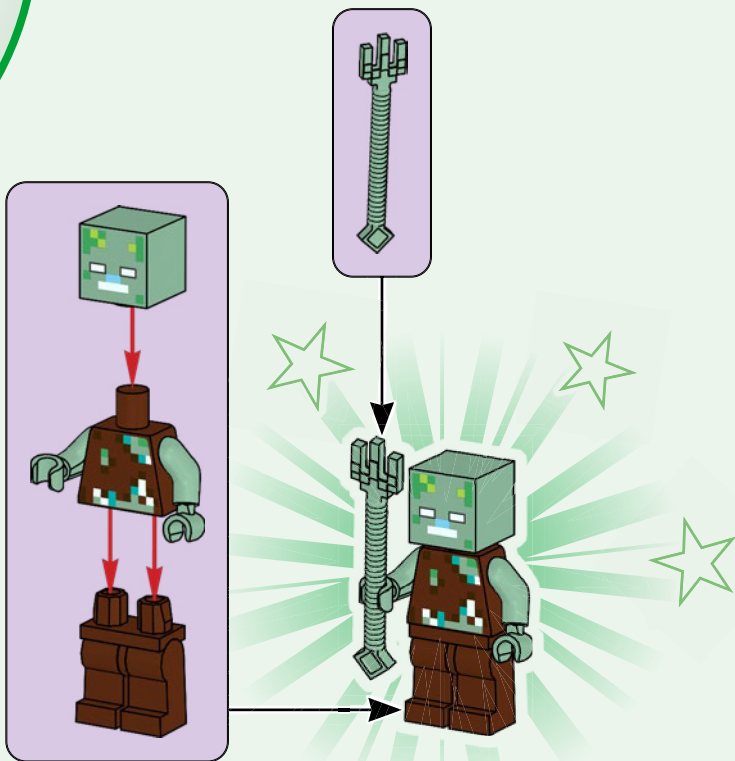

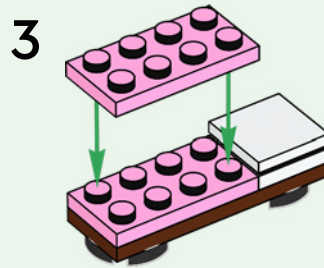
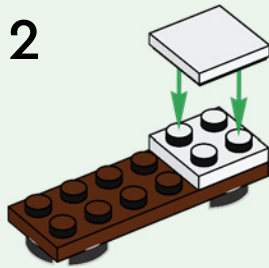
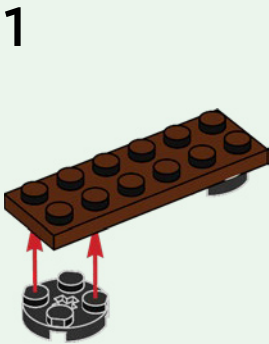
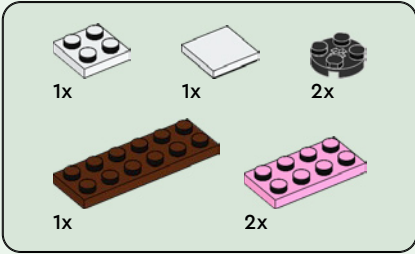

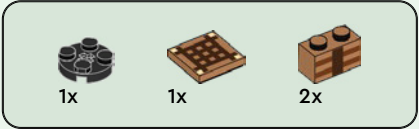

1



2

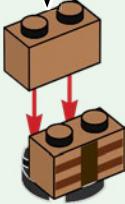
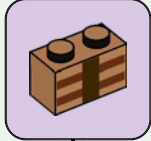

3



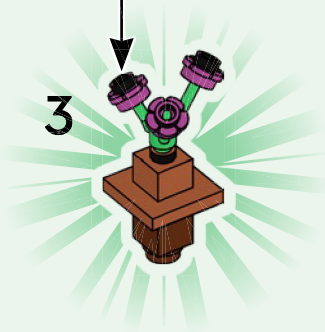
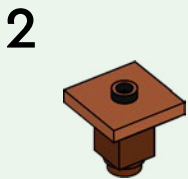
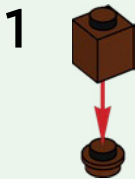
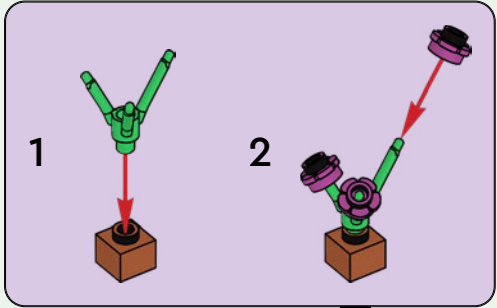
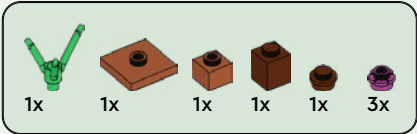

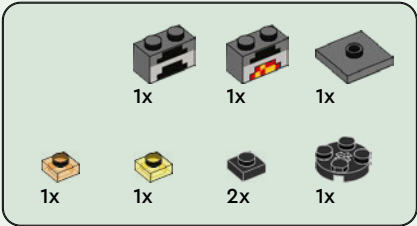

1



2

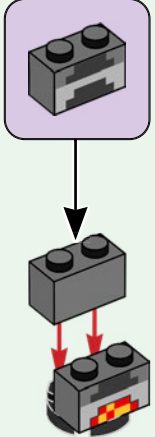

3



4

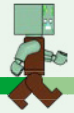
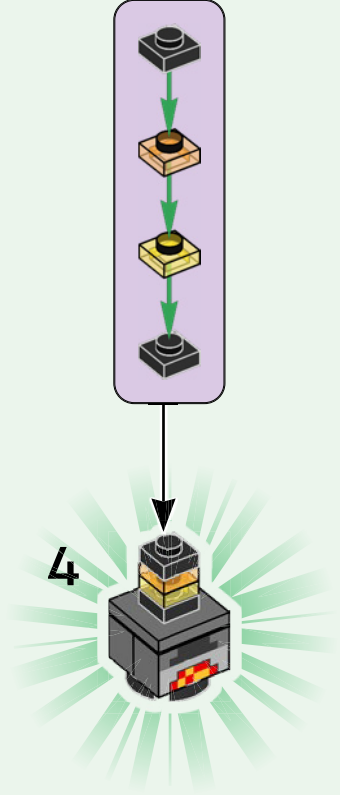



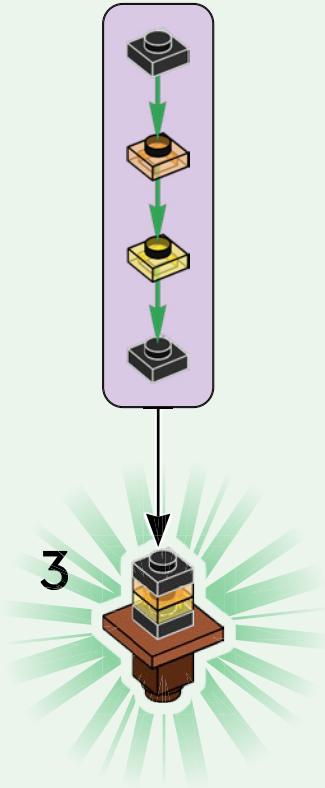
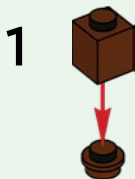

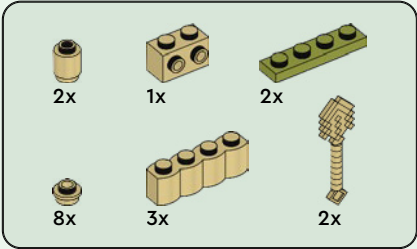

1

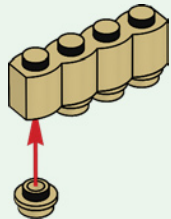

2

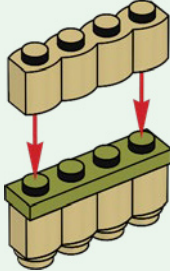

3

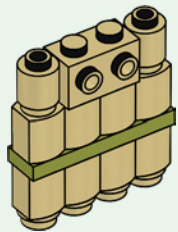

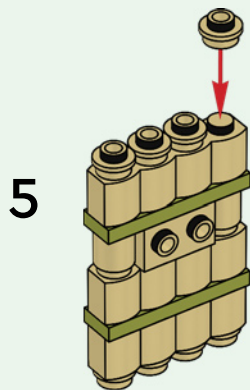
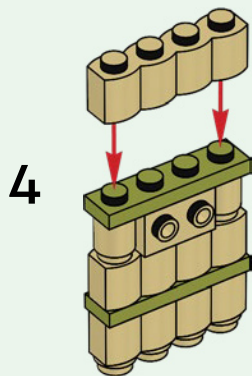

6

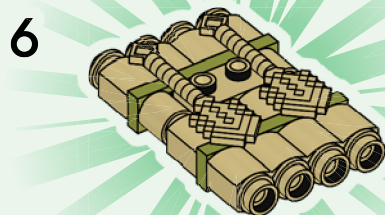

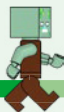
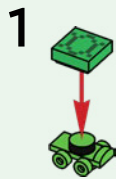

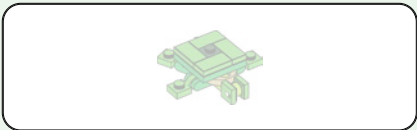

1



2

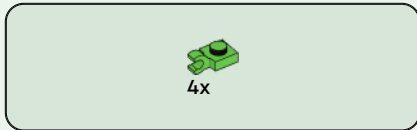
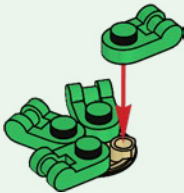

3

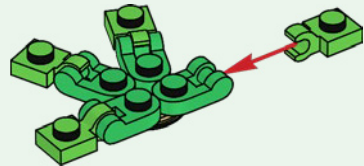

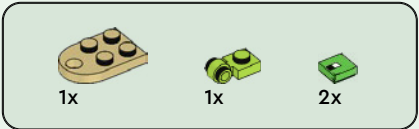

# 4

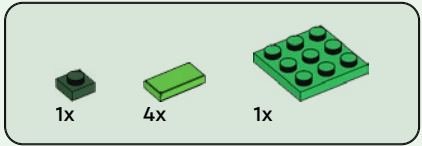
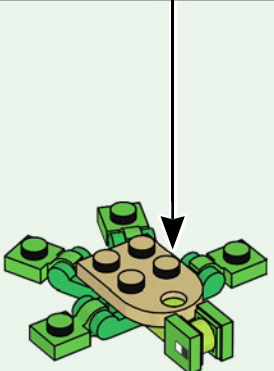
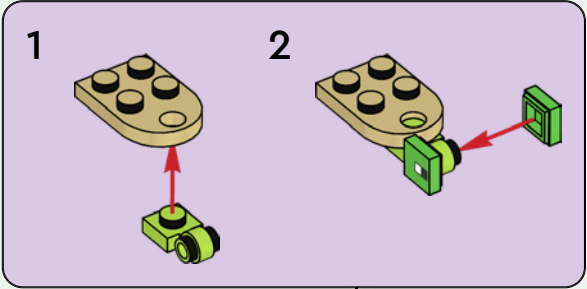

# 5

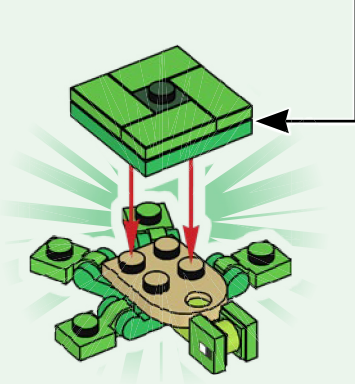
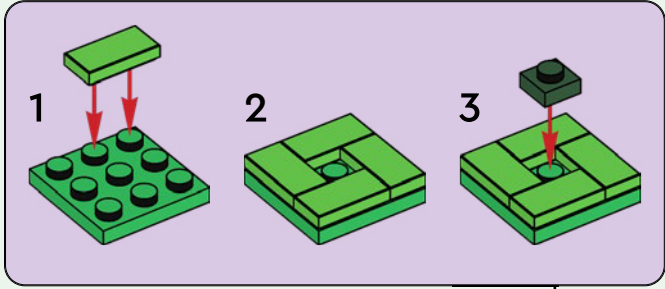

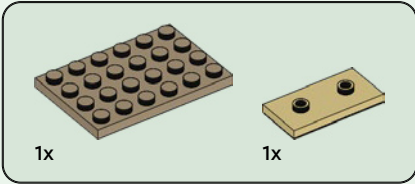
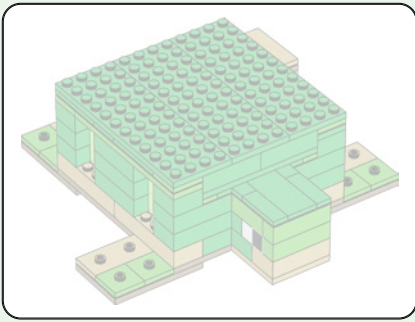

1

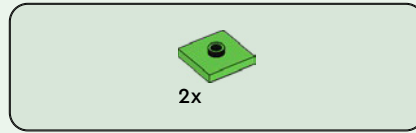
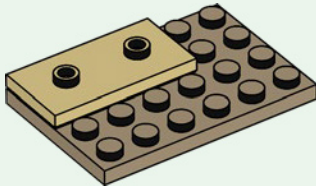

2

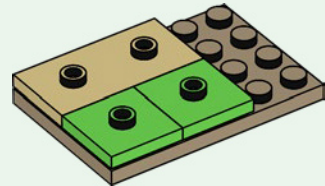

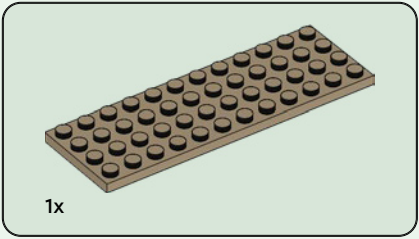

3

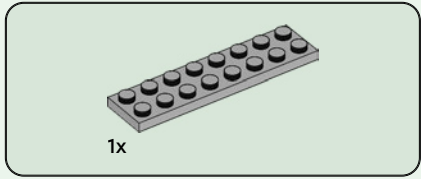
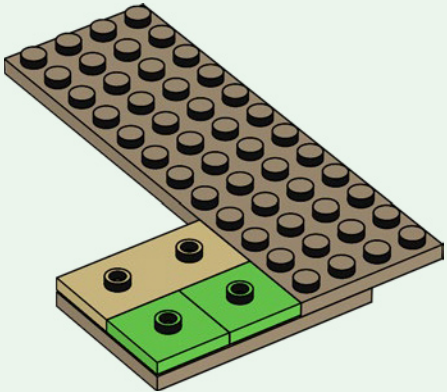

4

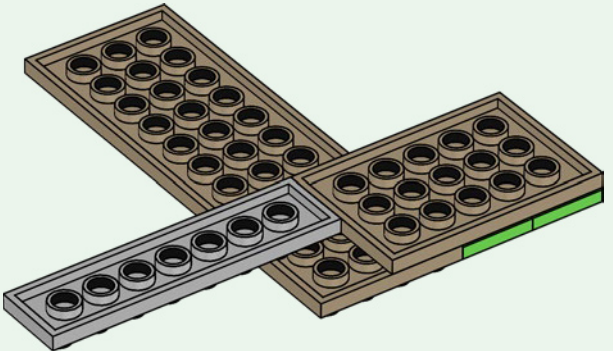



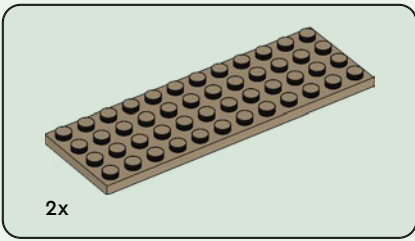

5

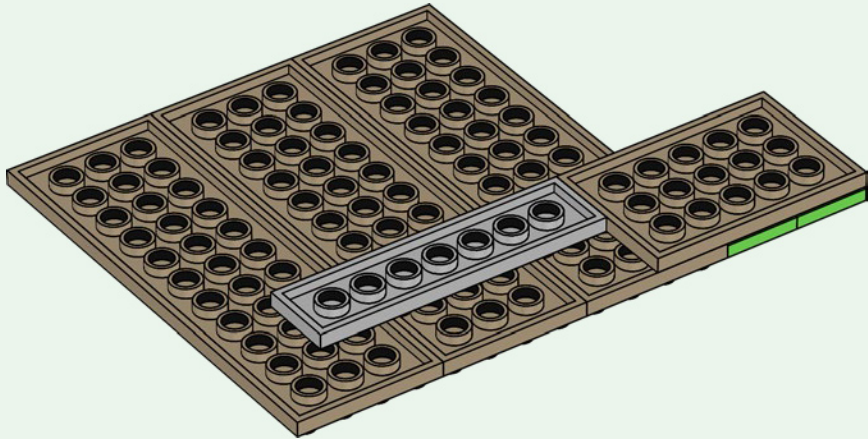

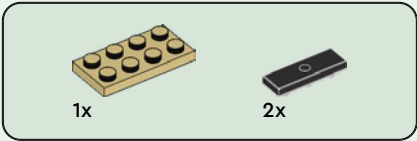

6

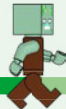
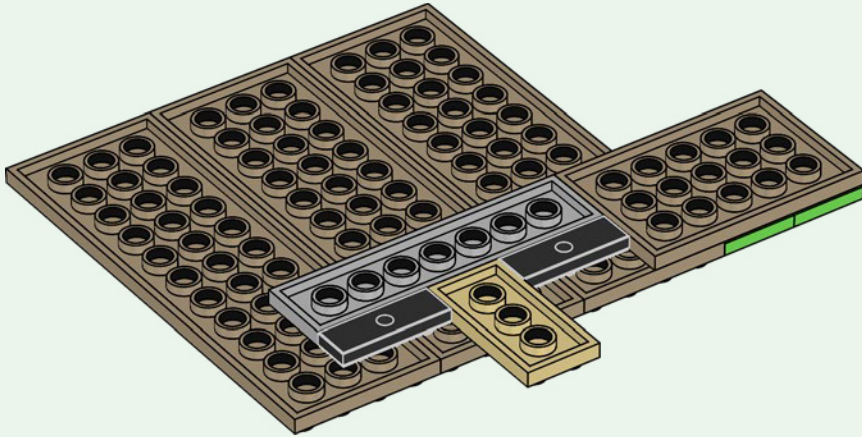



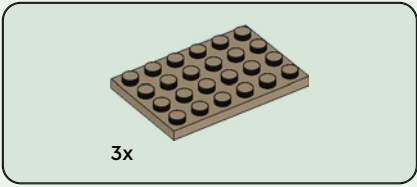

8

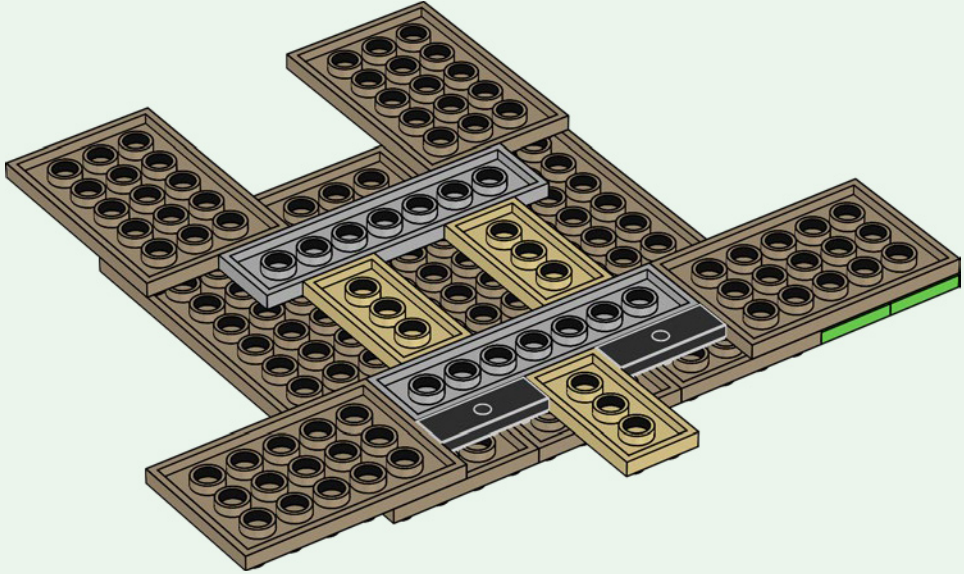





6x

10

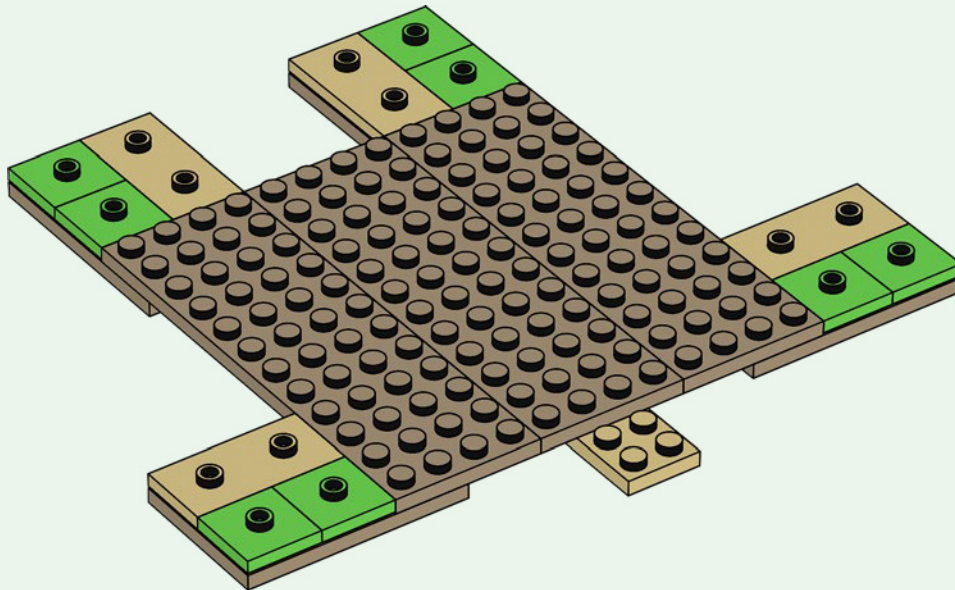

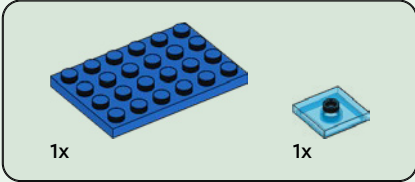
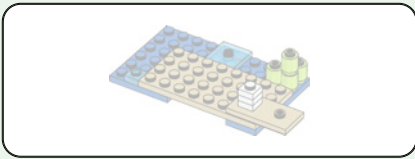

11

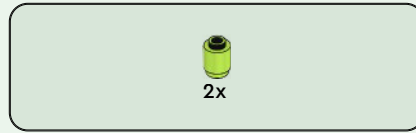
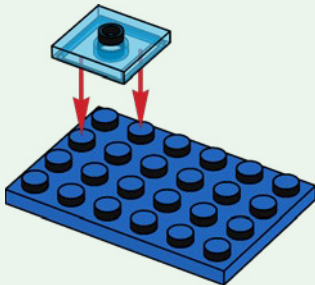

12

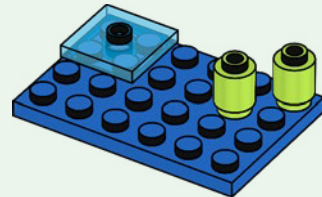



13

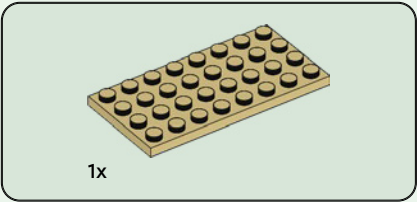
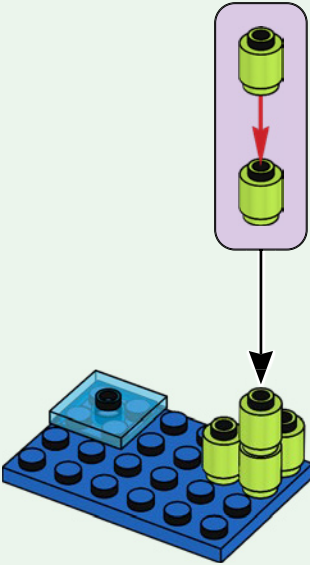

14

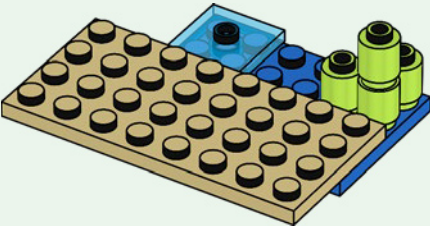



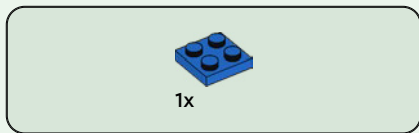

15

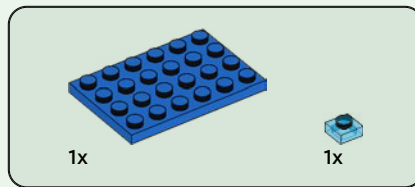
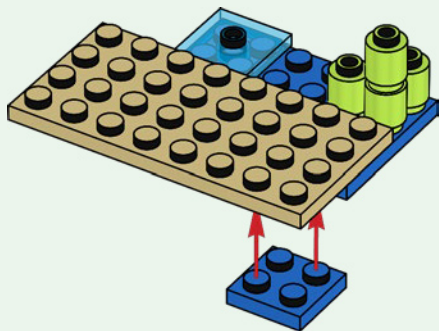

16

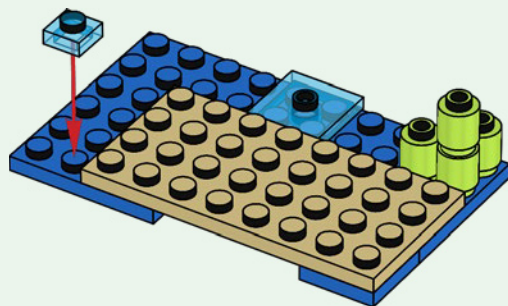

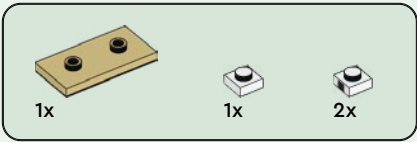

17

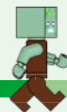
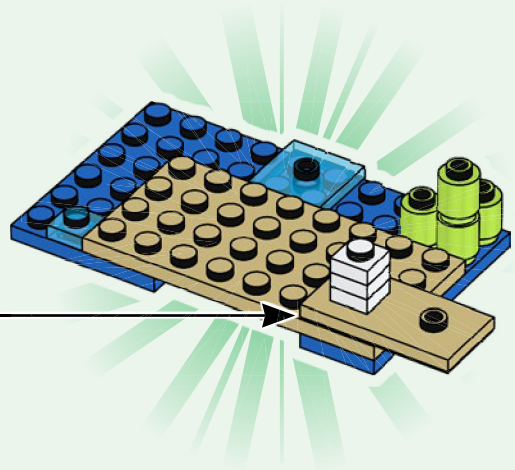
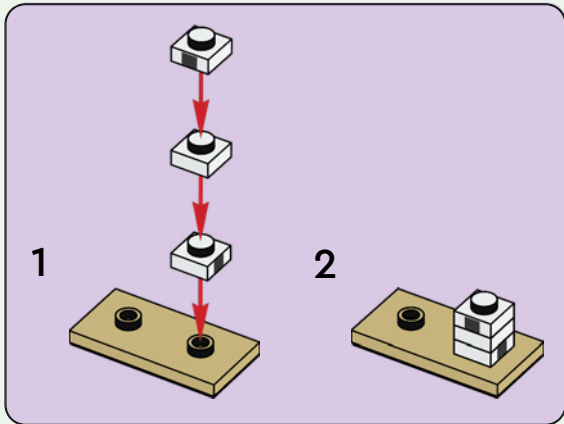

18

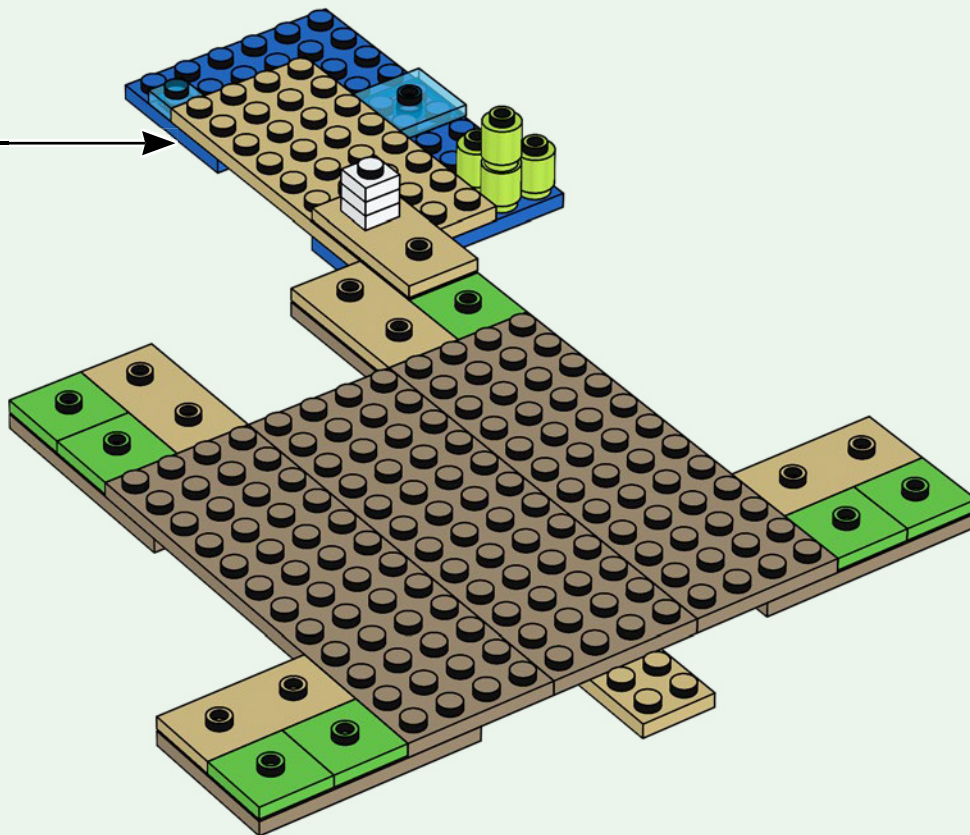

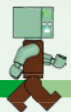
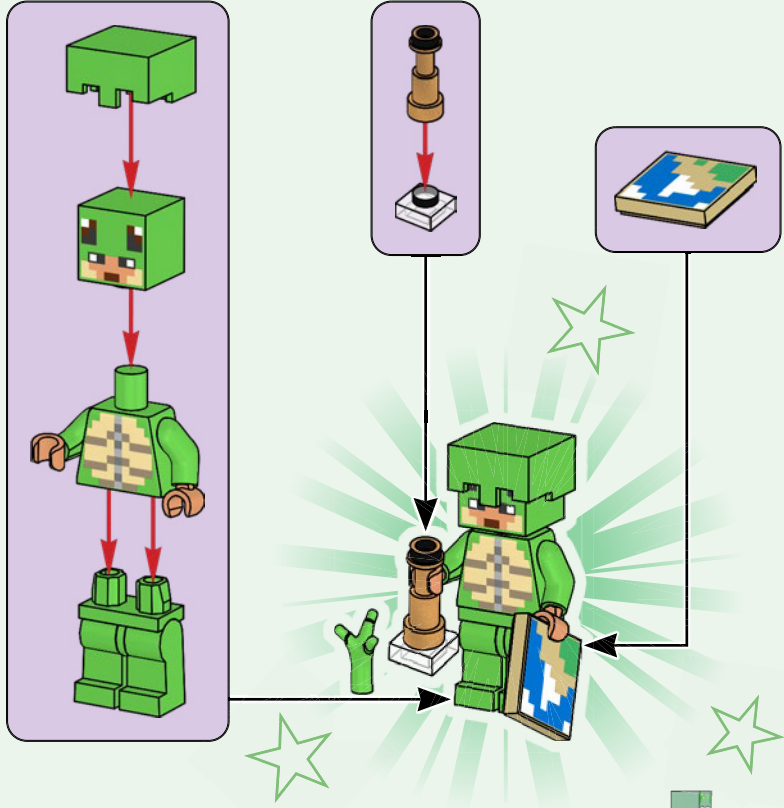
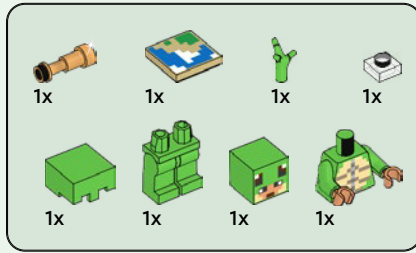

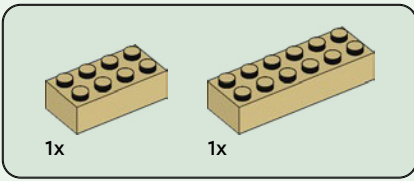

19

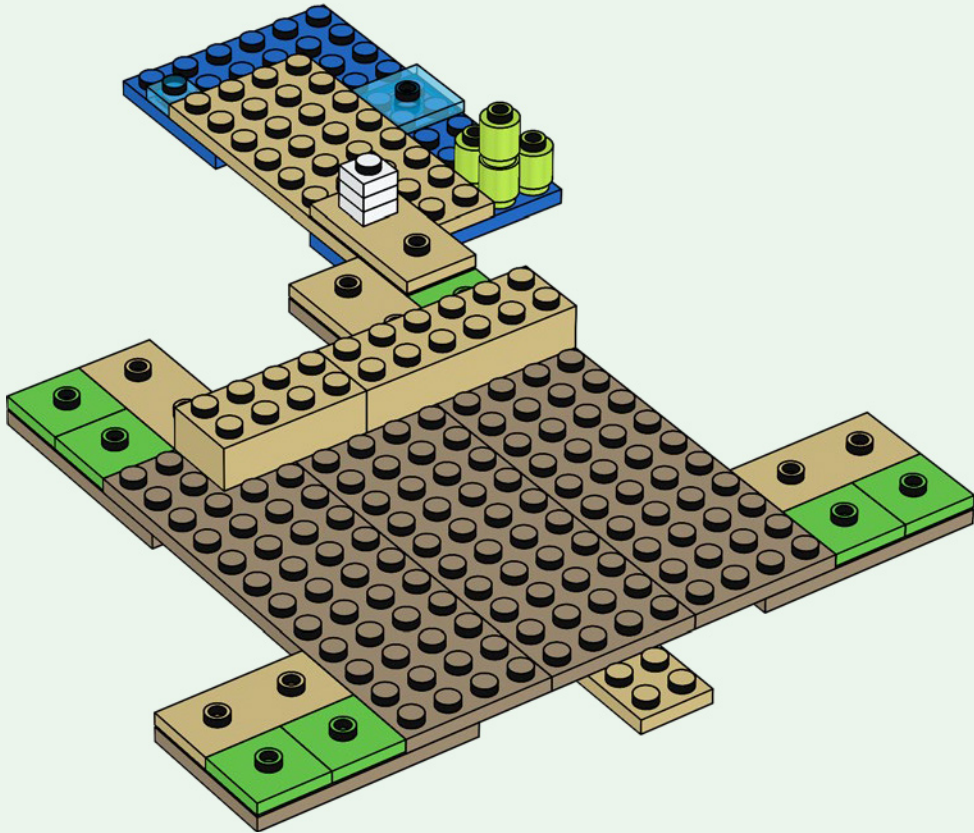

20

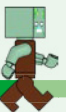
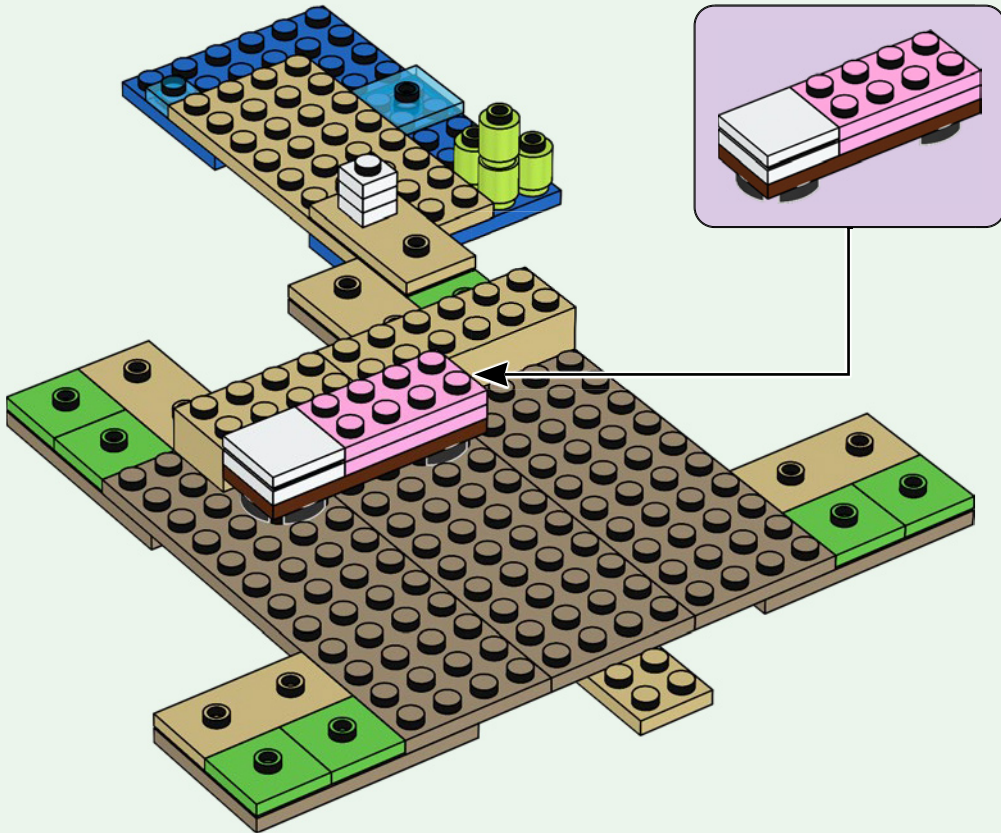

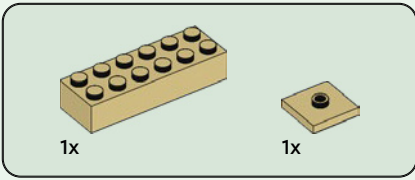

21

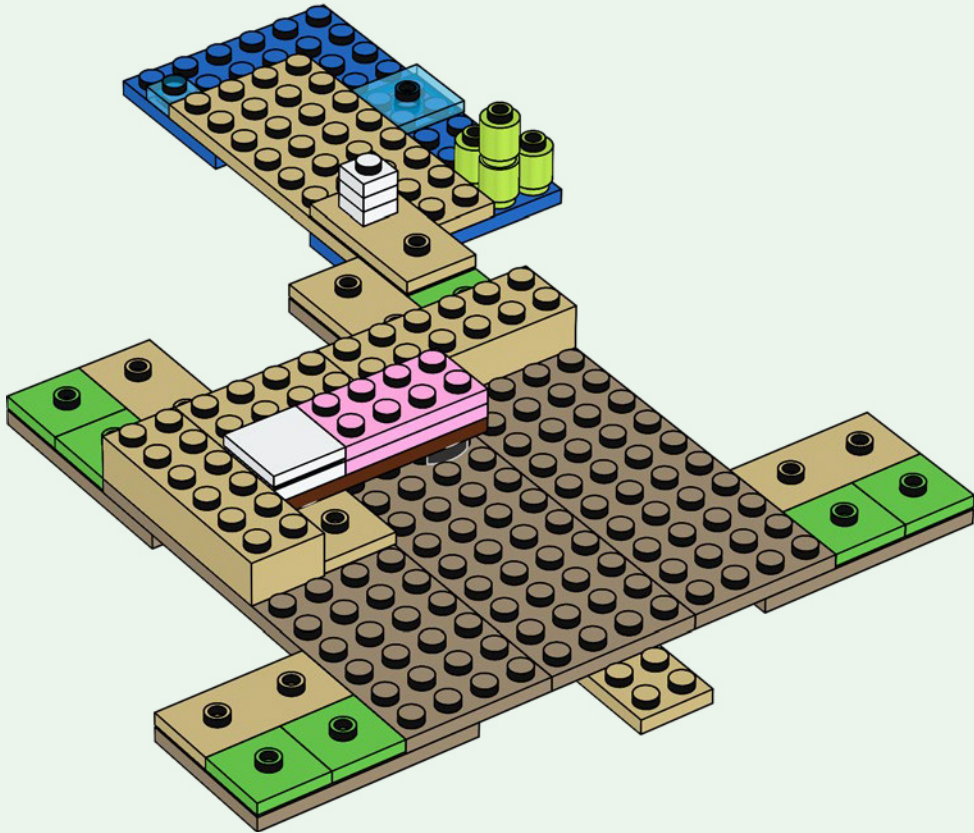

22

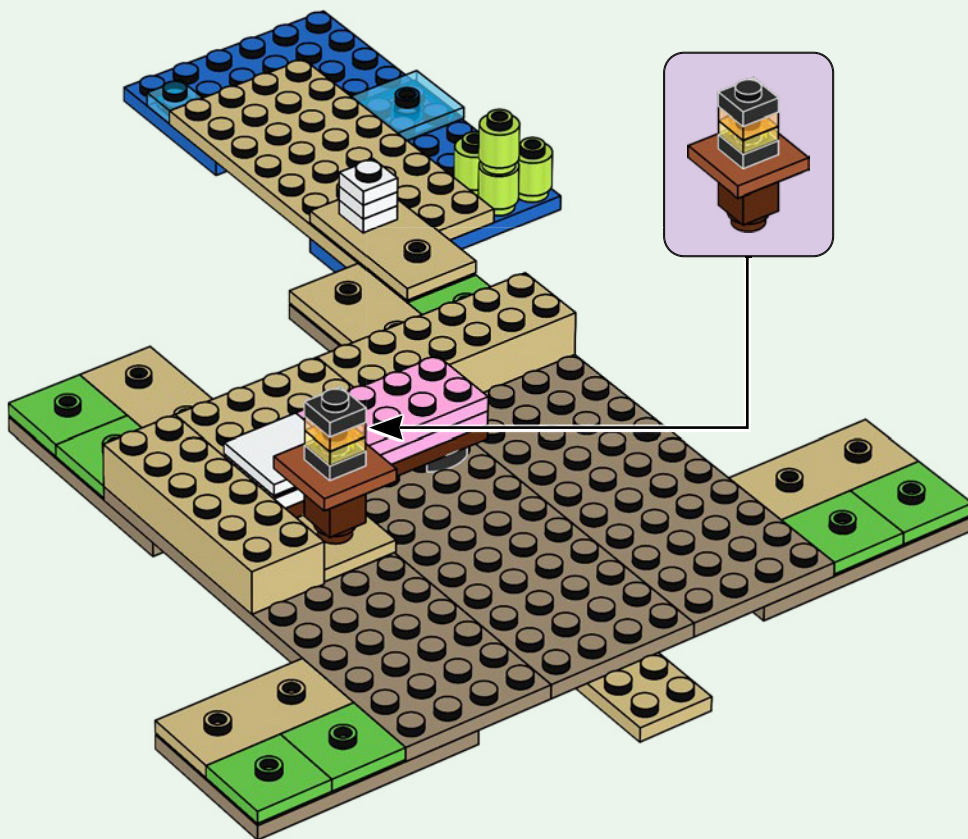



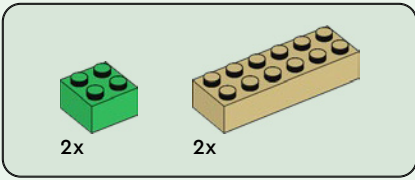

23

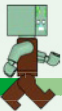
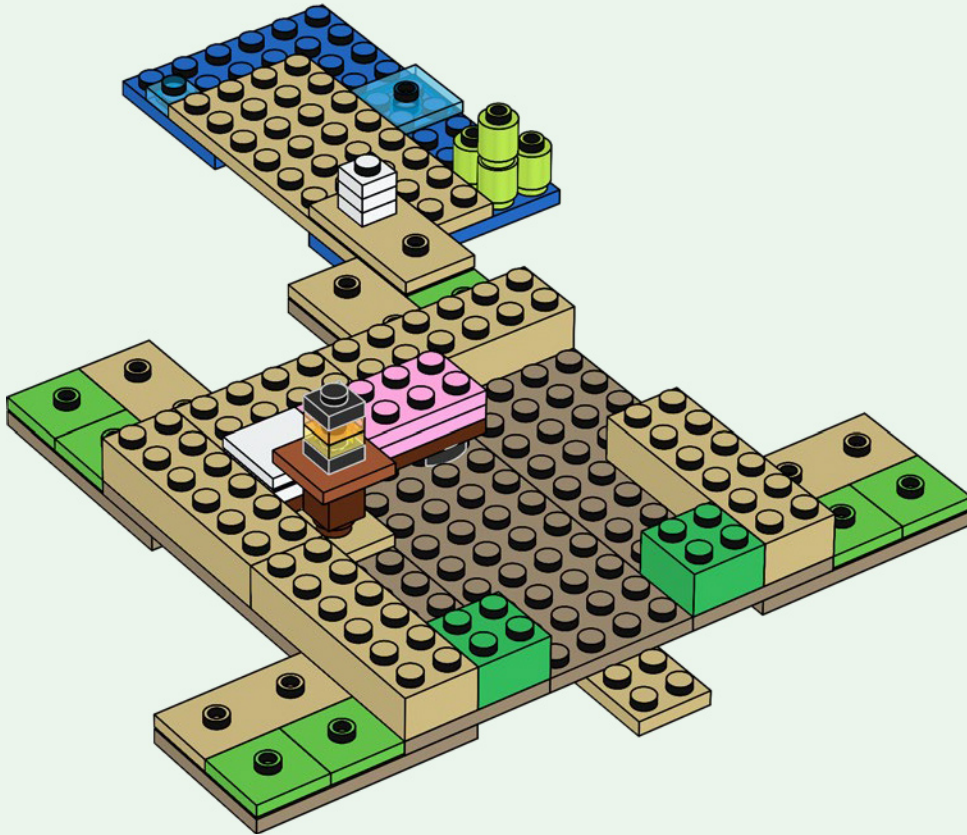

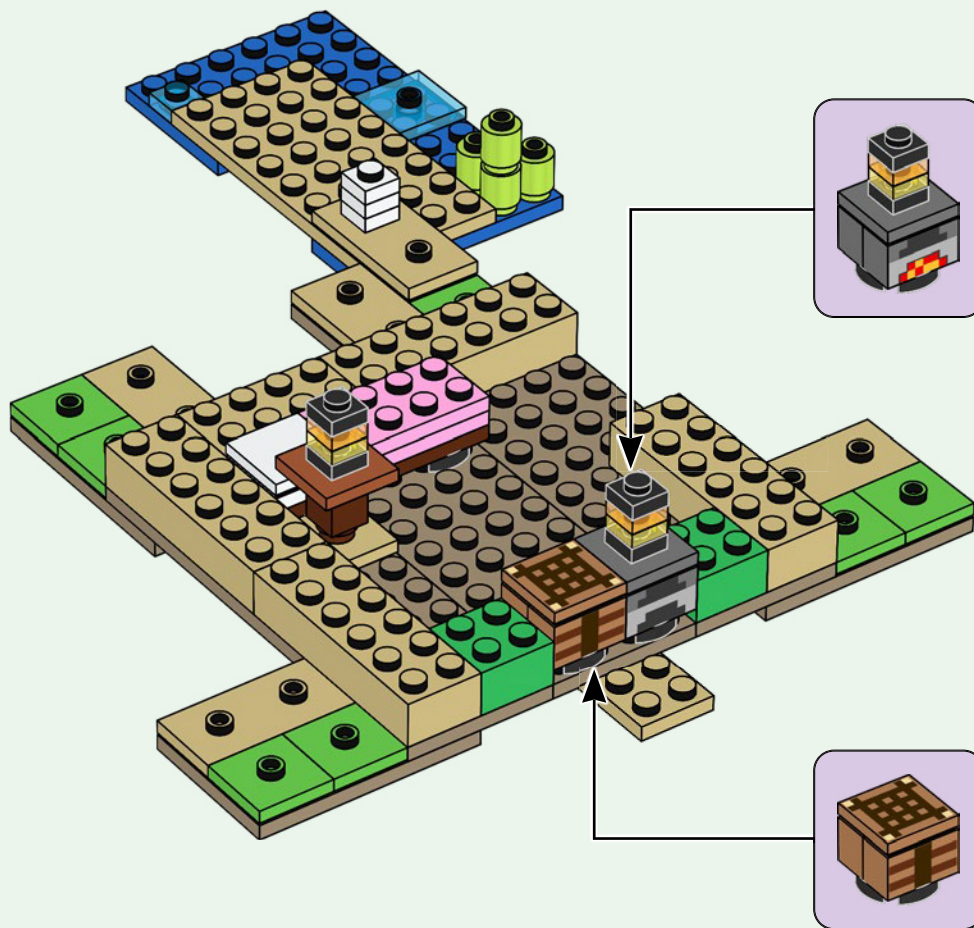







6x

27

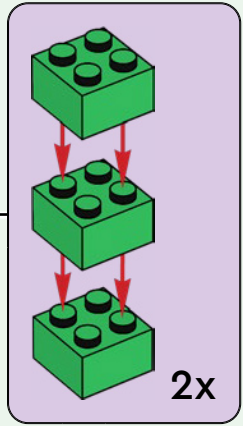
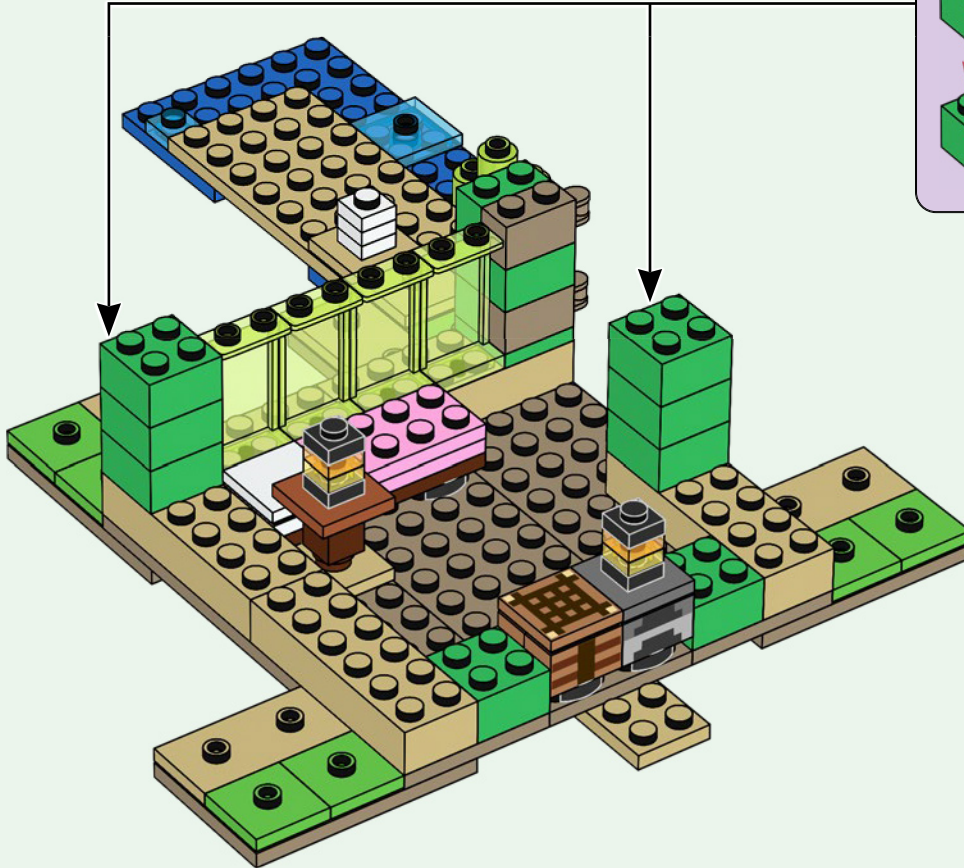

2x



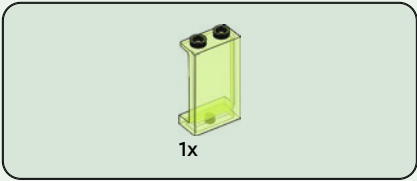

28

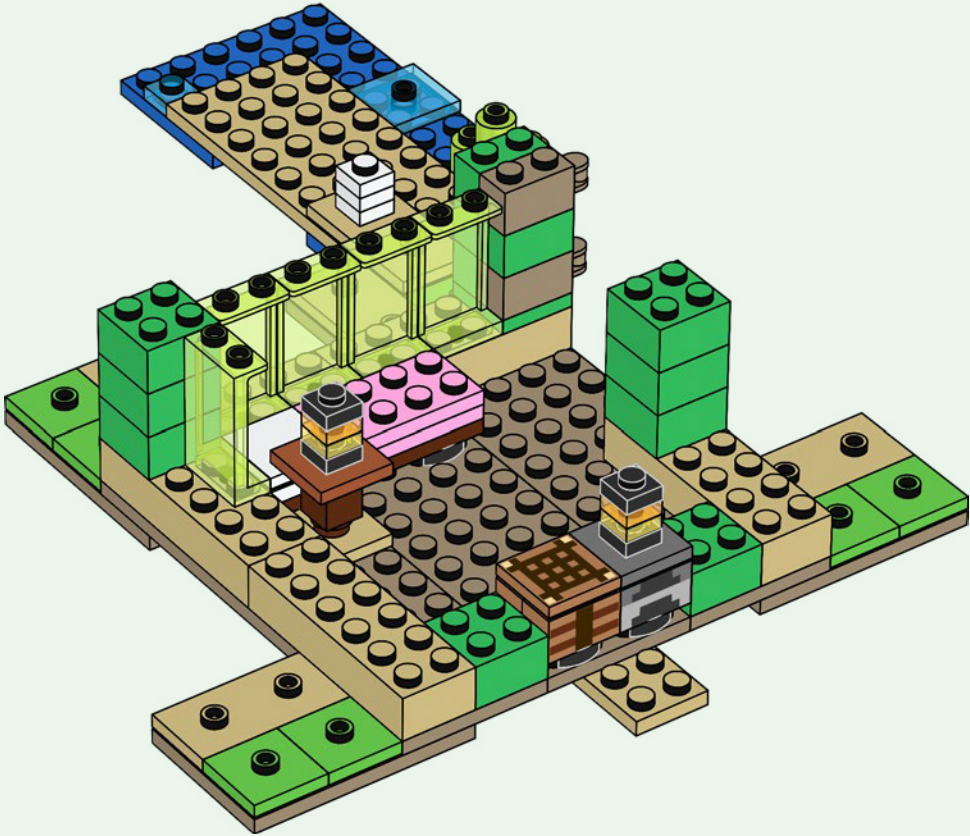

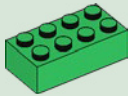

3x

29

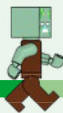
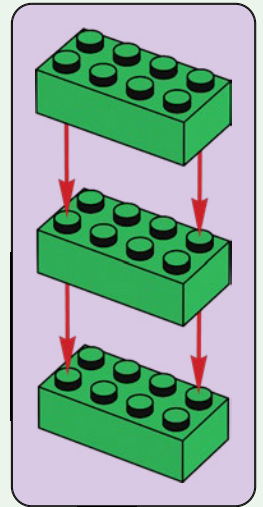
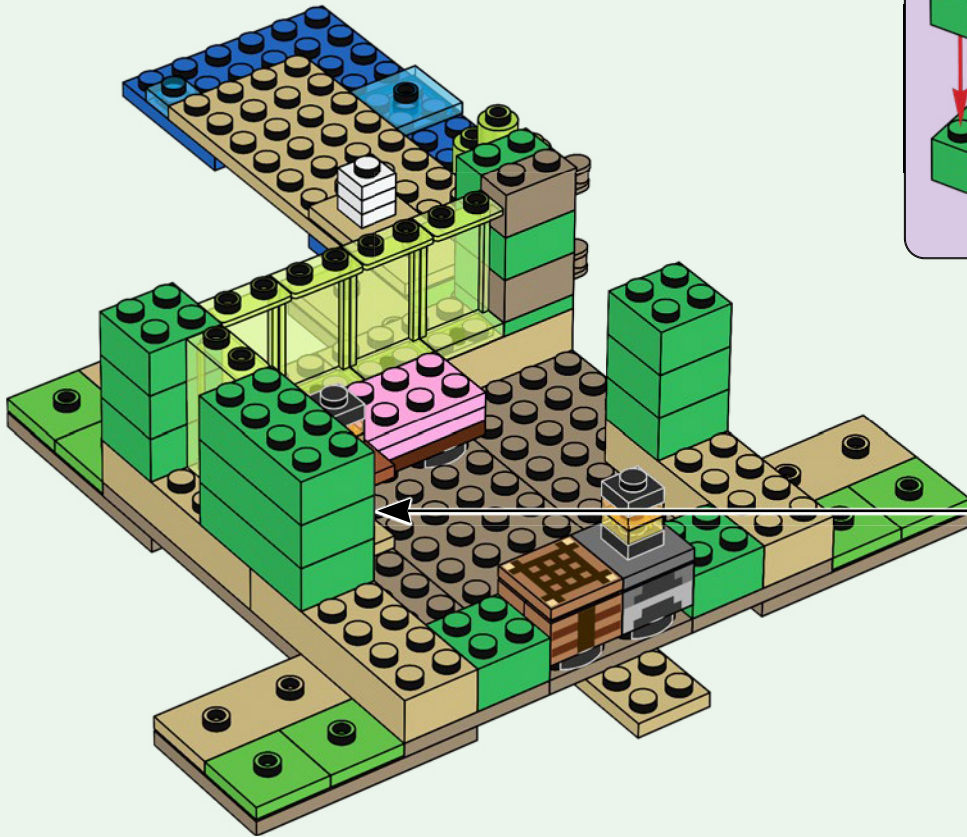



2x

30

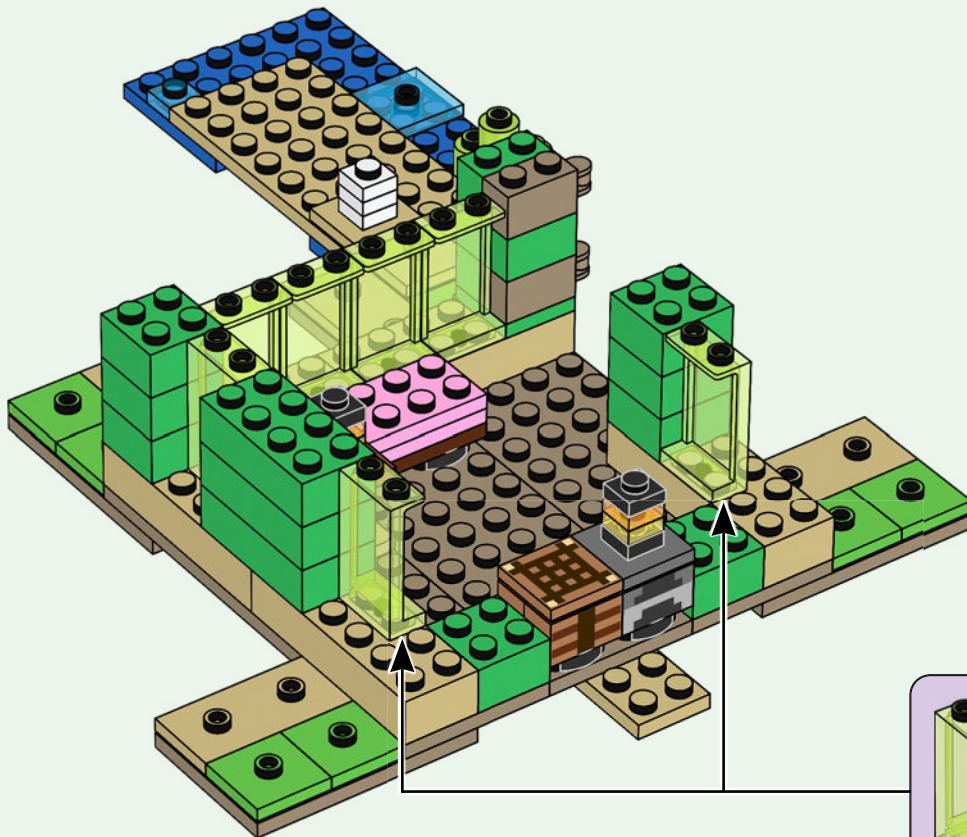

2x



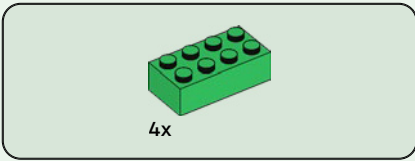

31

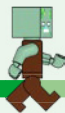
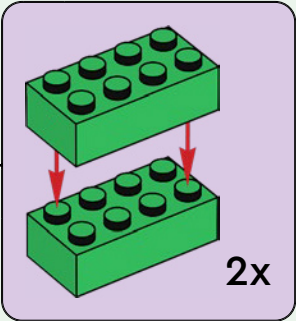
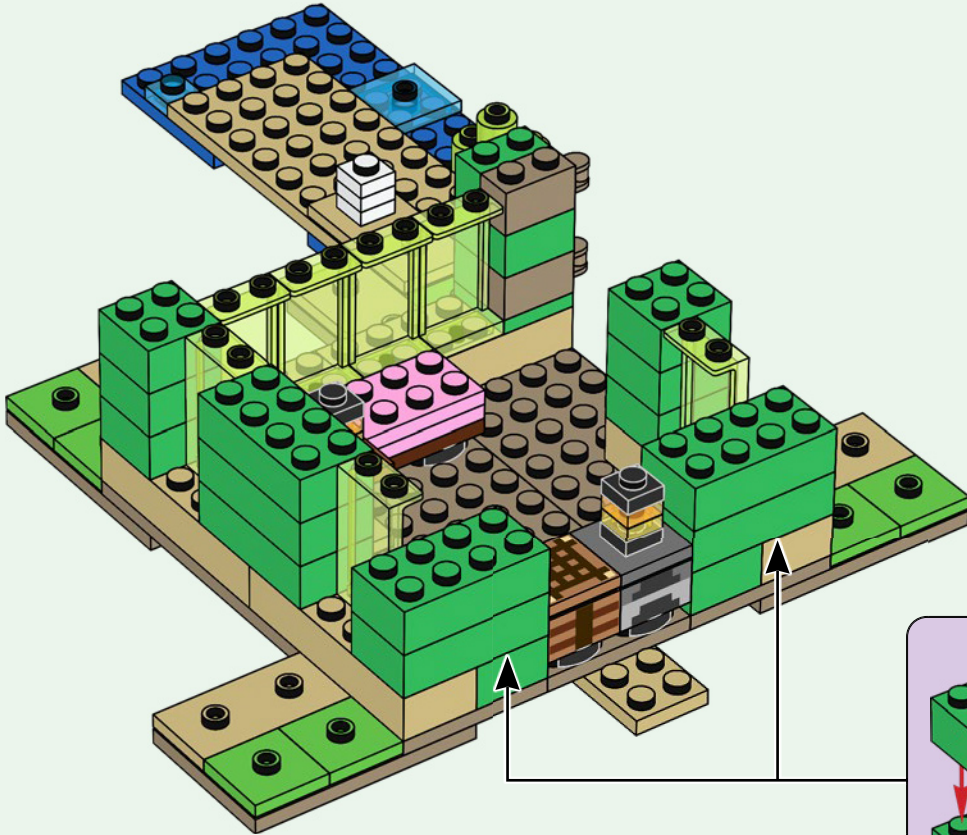



2x



2x



2x

# 32

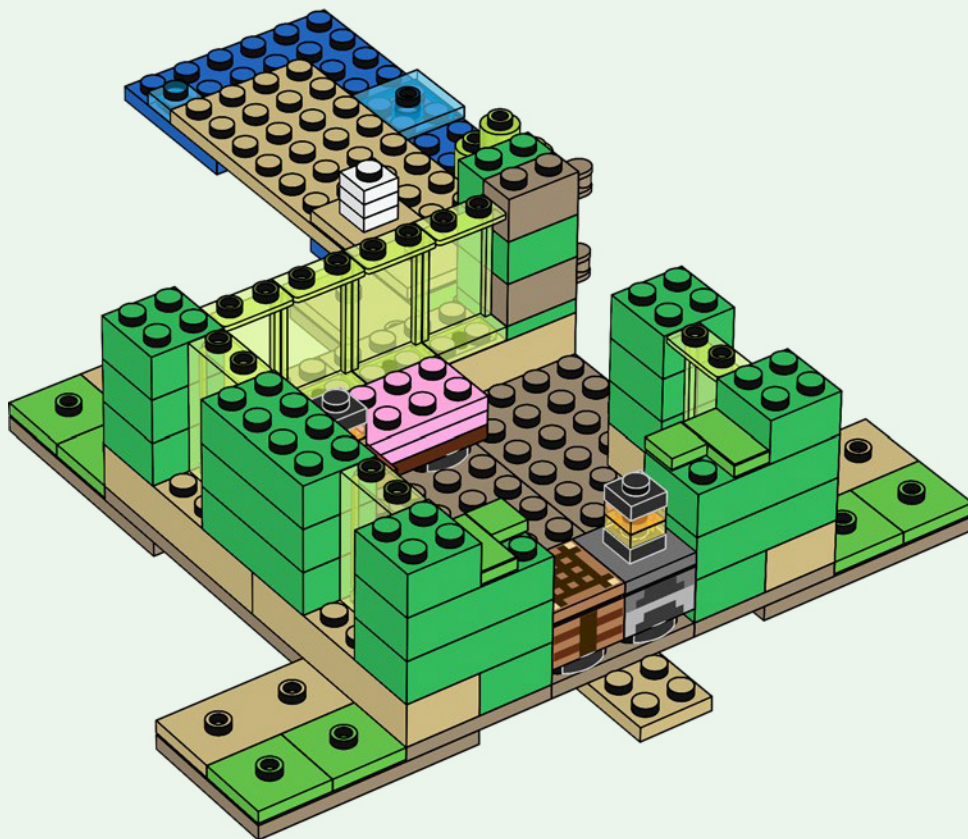

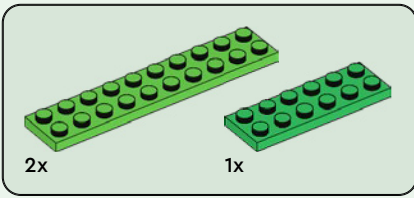

33

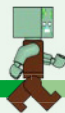
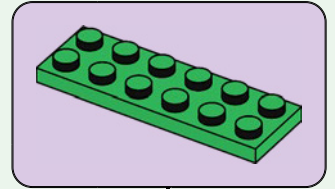
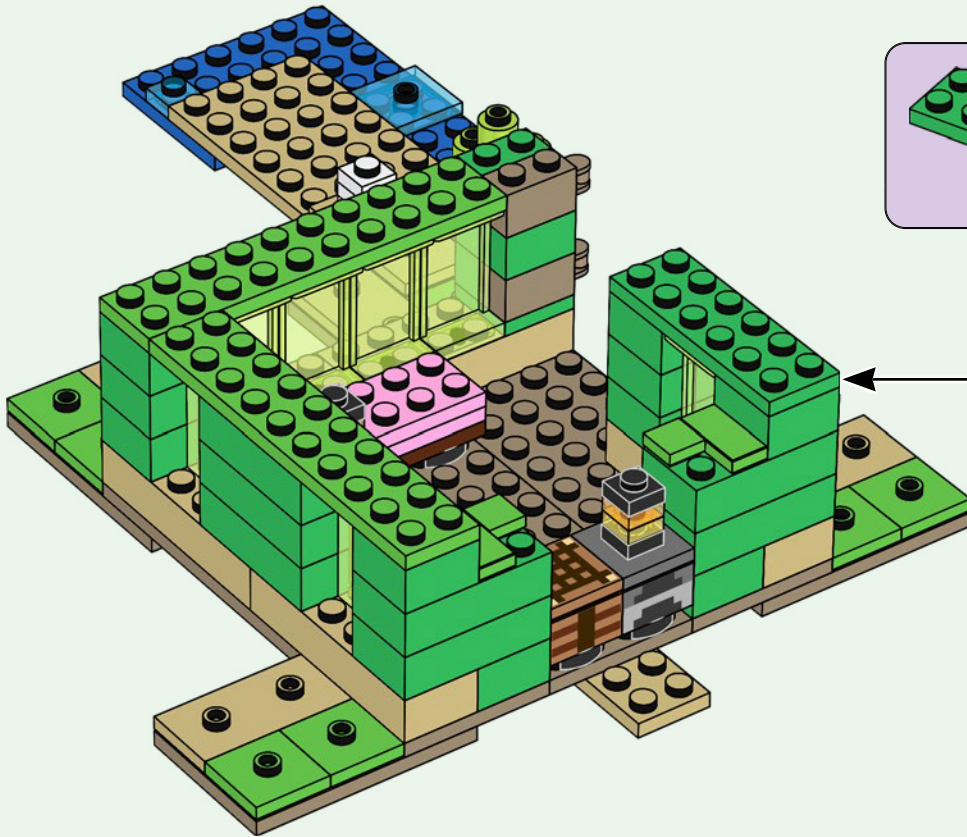

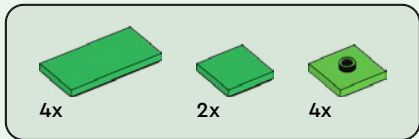

34

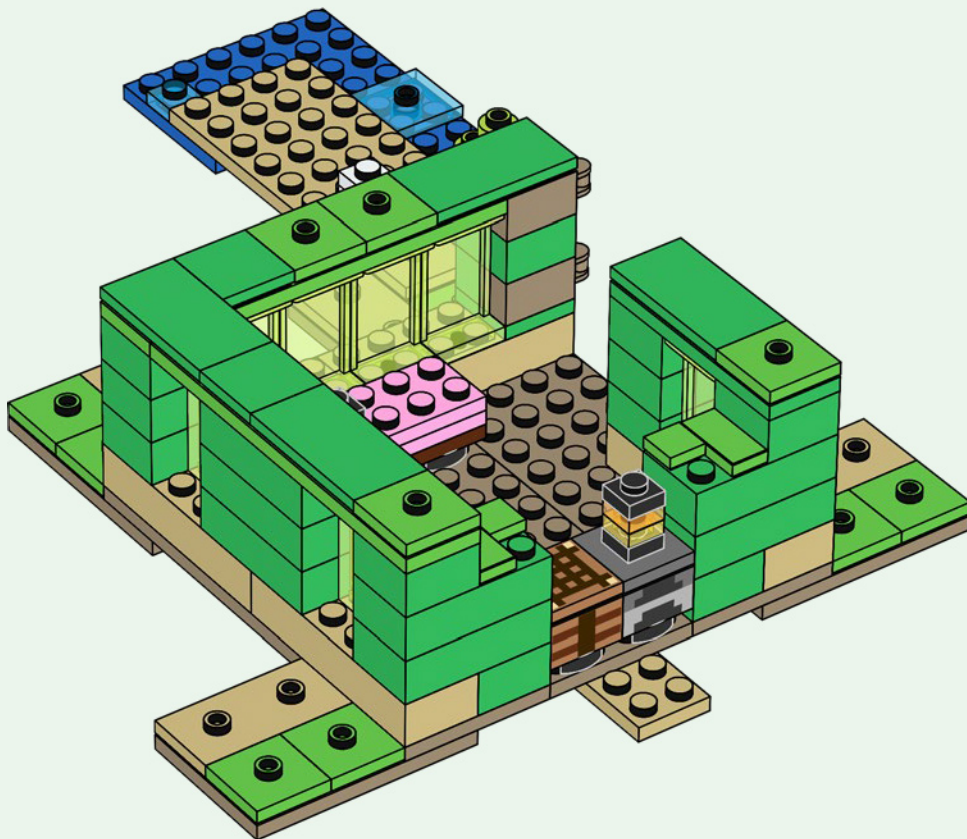

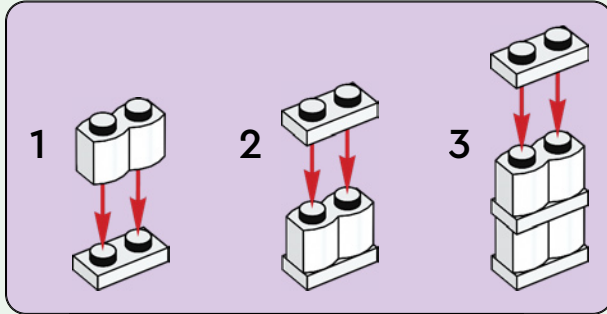
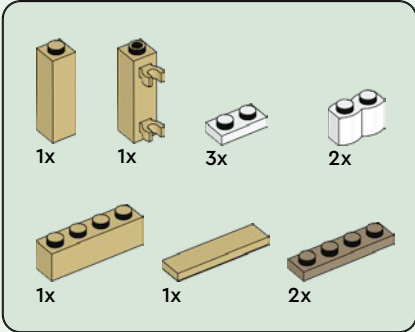
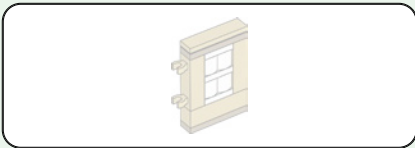

35

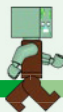
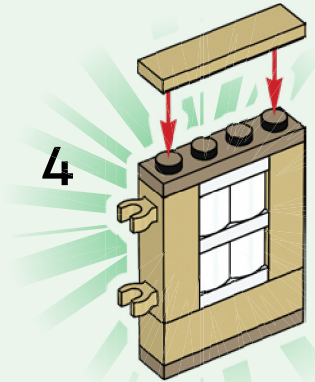
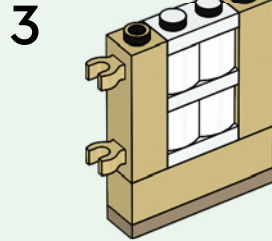
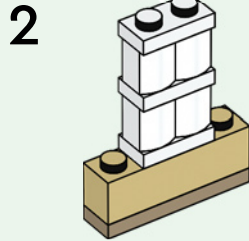
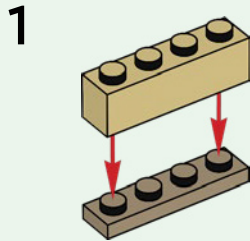

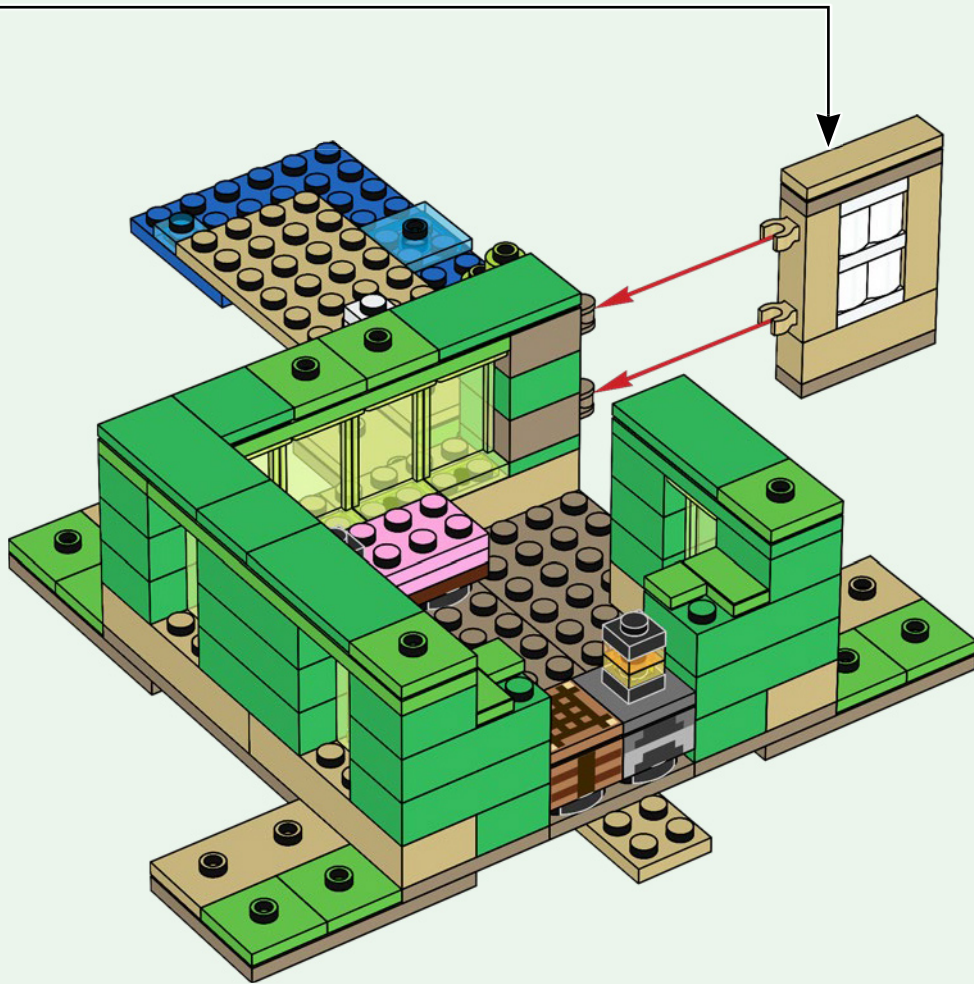

36

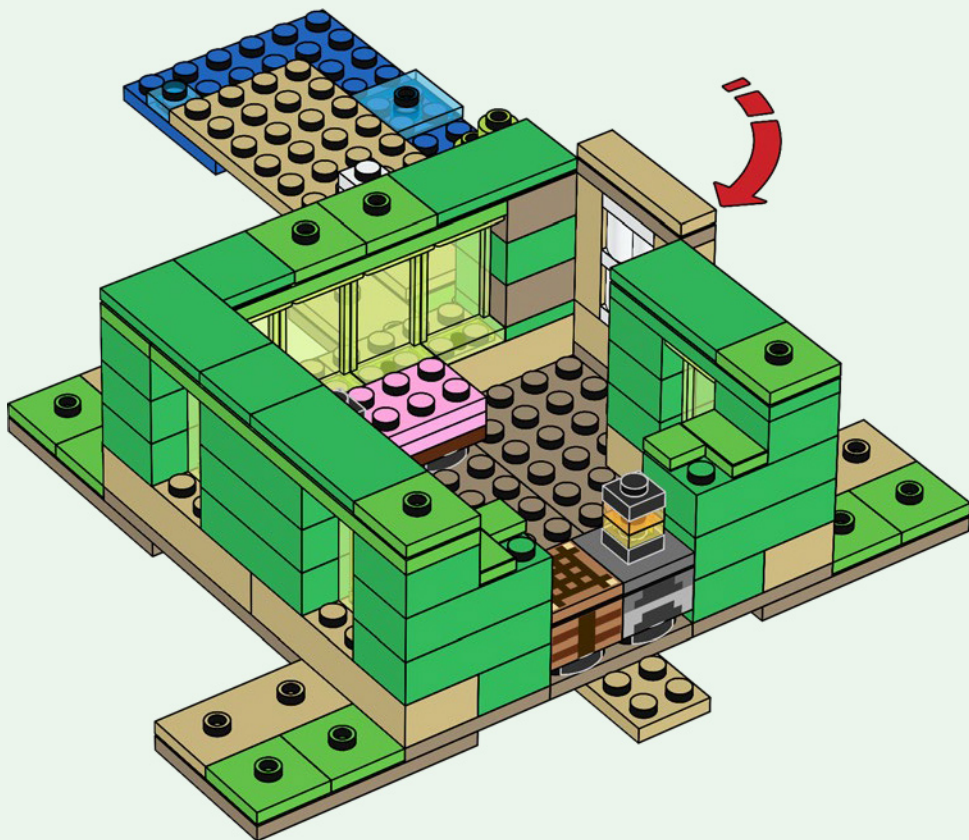

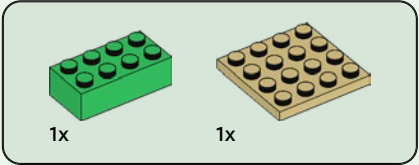
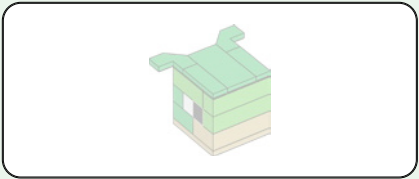

37

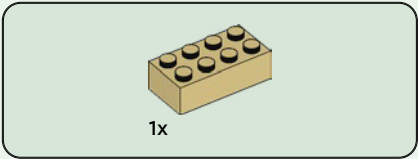
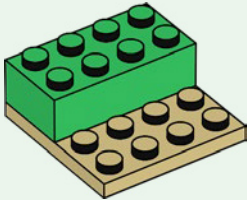

38

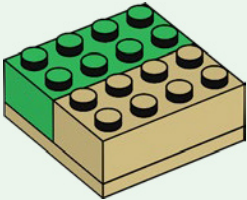





2x

# 39

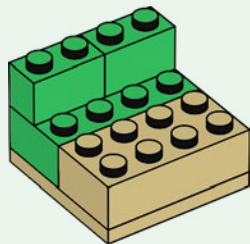

1x



1x

# 40

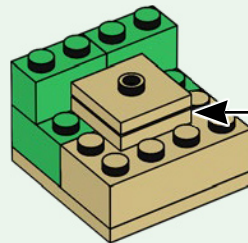
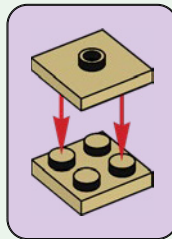

2x



2x

# 41

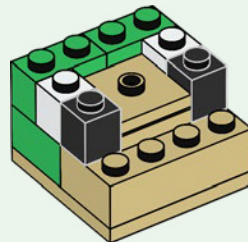

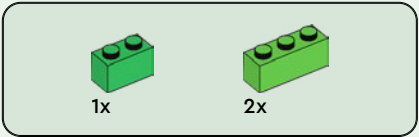

42

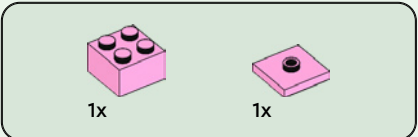
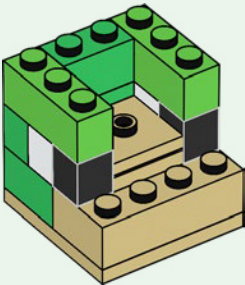

43

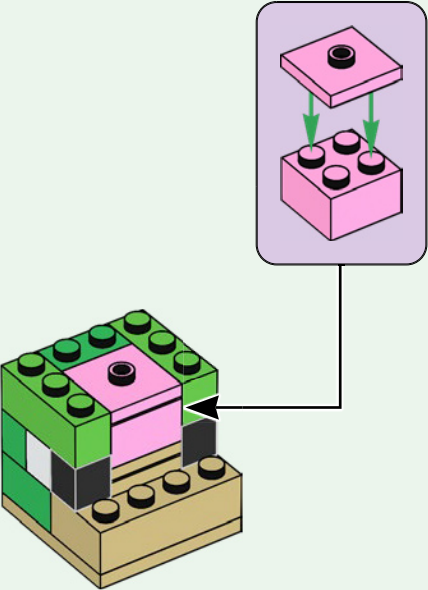

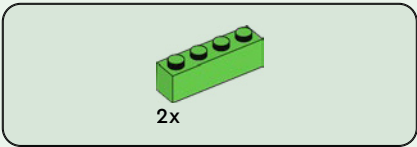

44

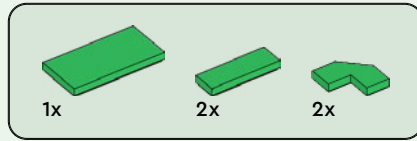
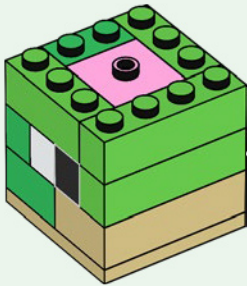
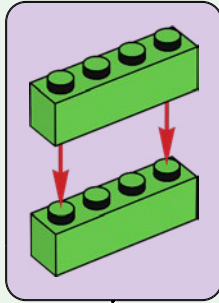

45



46

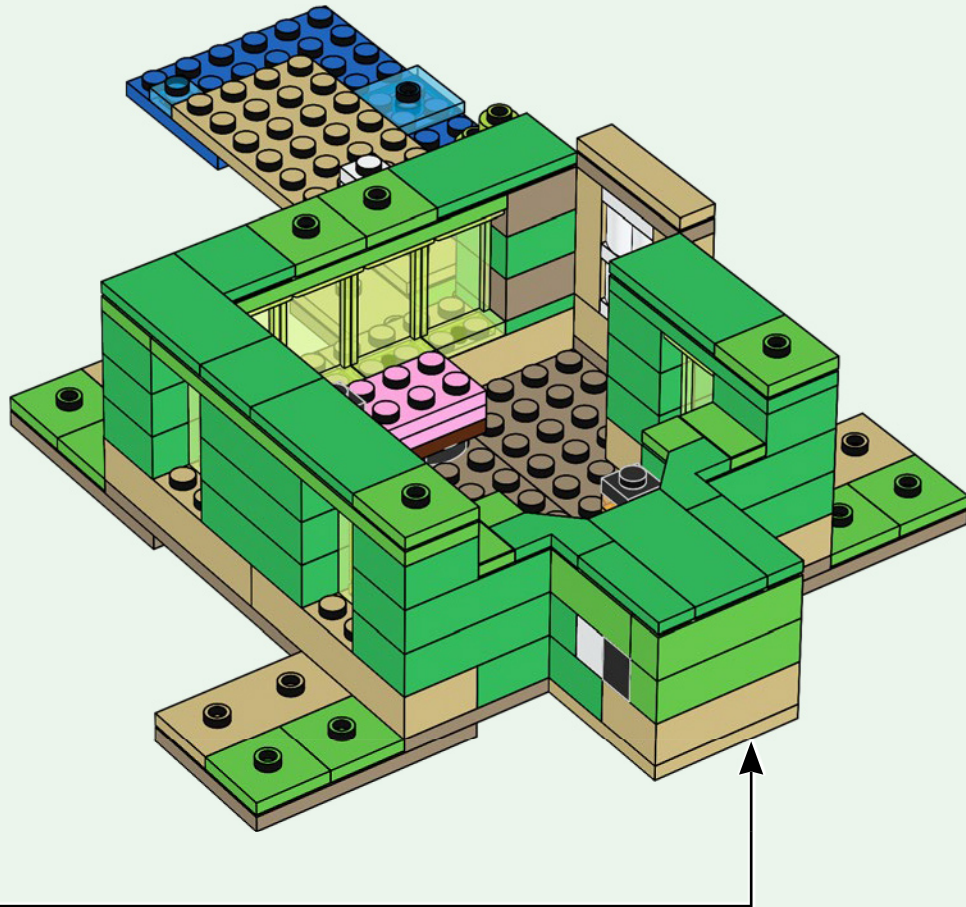

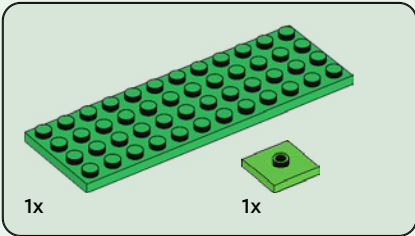
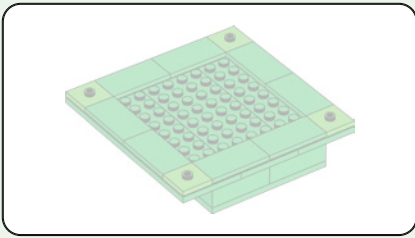

47

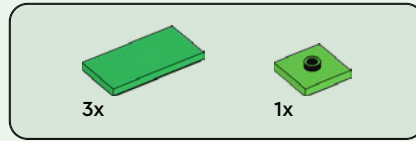
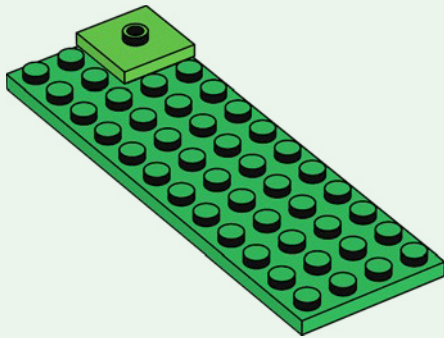

48

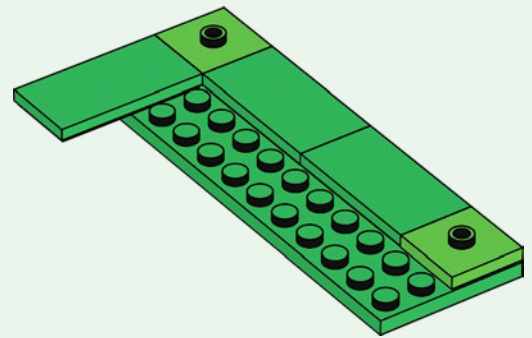

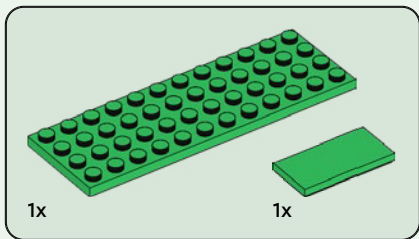

49

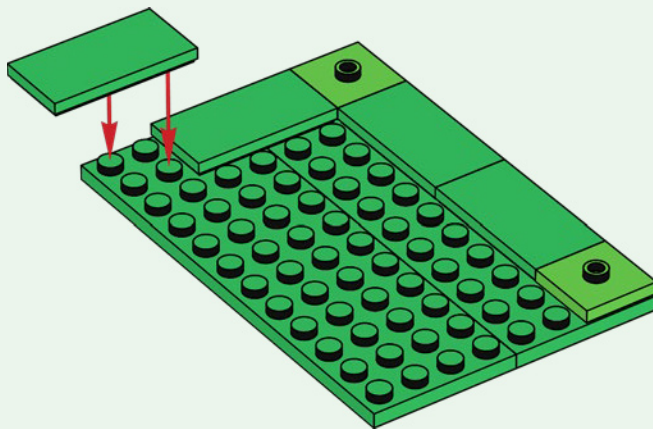

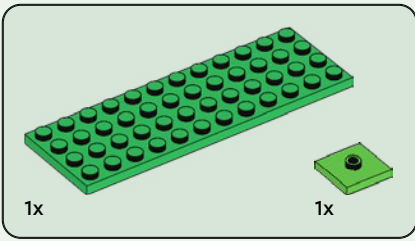

50

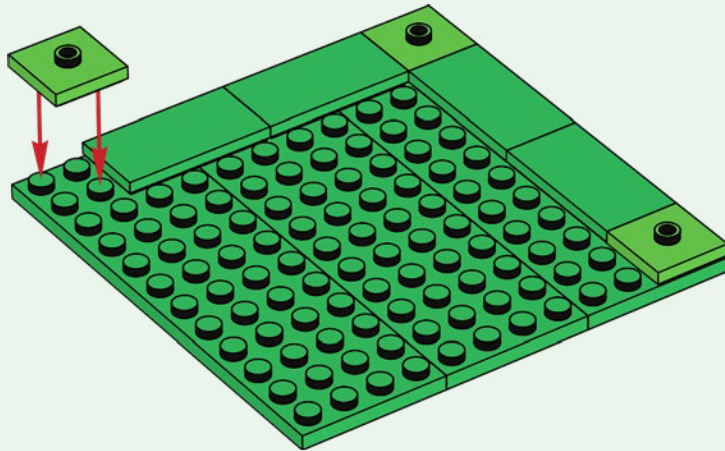

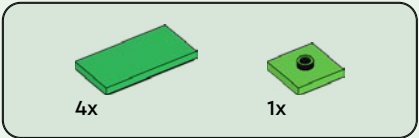

51

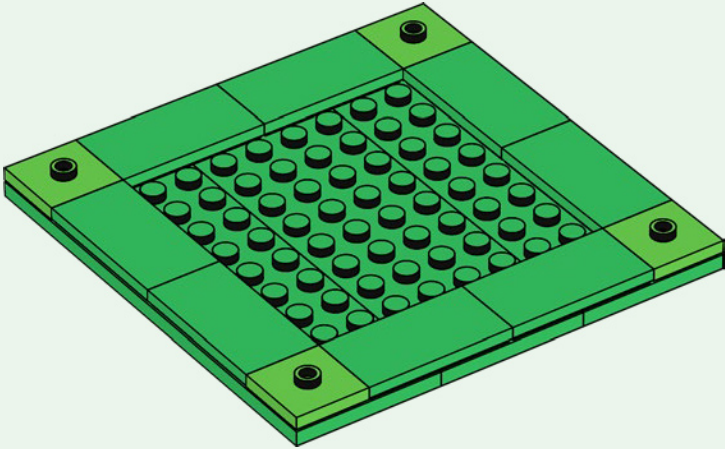



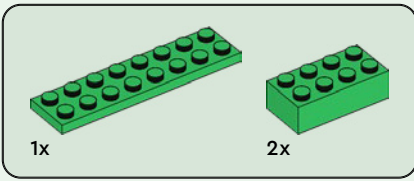

52

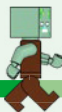
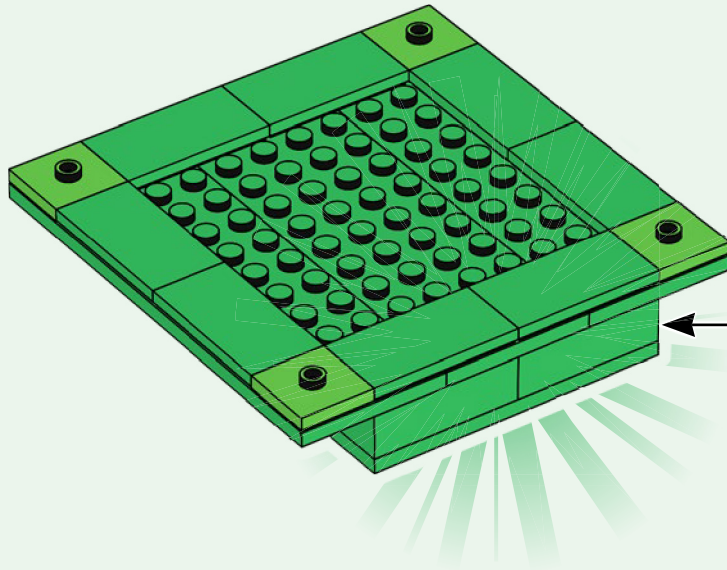
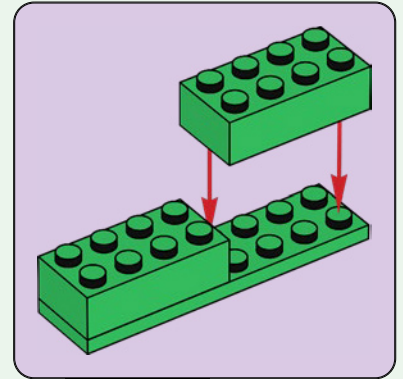

53

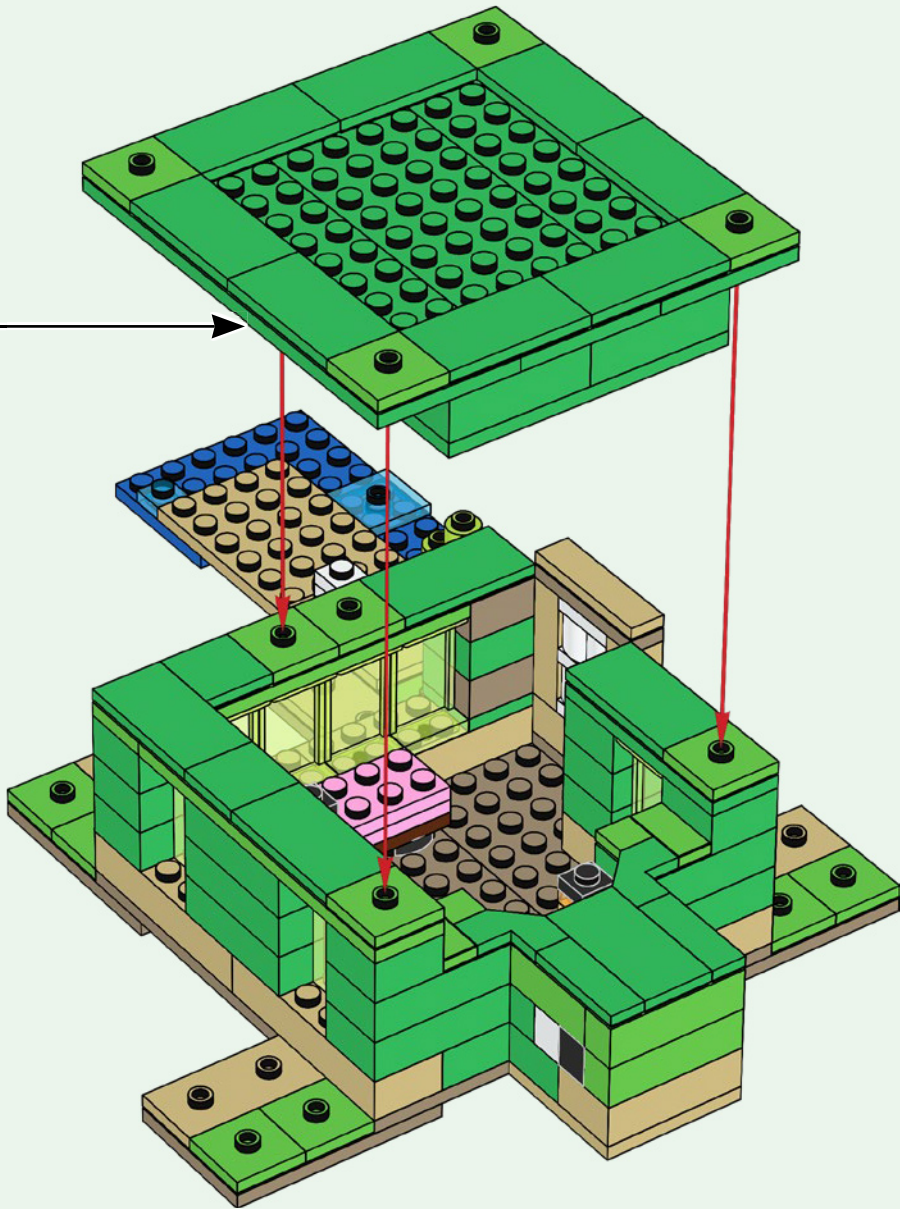





# MINECRAFT

21256



21257



21251

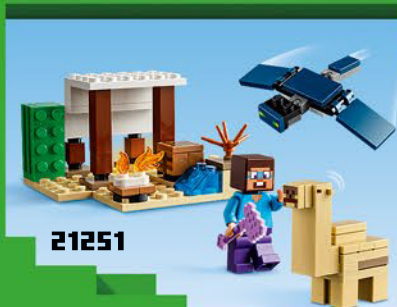

21255



21252



21253



21254



# MINECRAFT

Combine sets to expand your play!  
Kombiniere Sets für noch mehr Spielspaß!  
Combine les niveaux pour étendre ton expérience de jeu !  
Combina i set per espandere il tuo gioco!  
¡Combina sets para jugar mucho más!  
Combina sets para expandir os teus momentos de diversão!  
组合系列套装, 增强玩乐体验!  
łącz zestawy i baw się jeszcze lepiej!

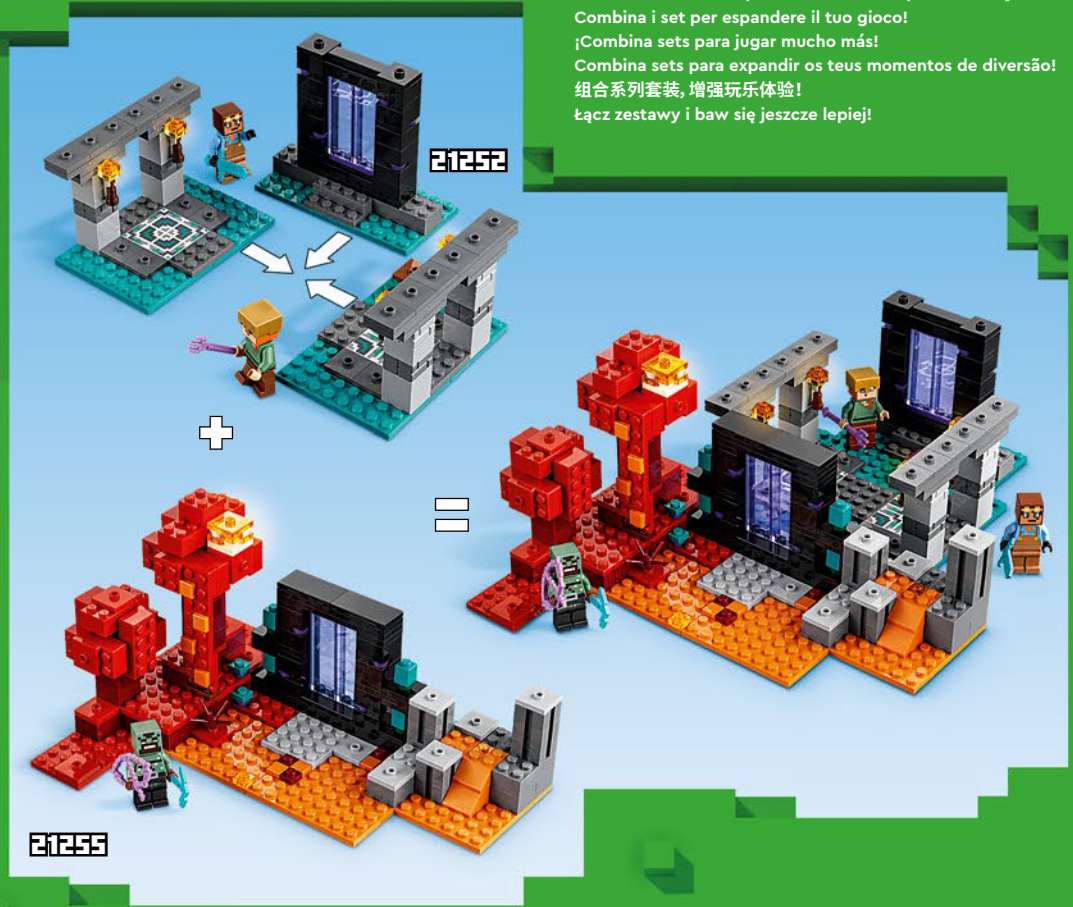

Kombinujte stavebnice a rozšiřujte svou hru!  
Kombinujte stavebnice a rozšiřujte herné možnosti!  
A készletek egyesítésével bővítsd a játékot!

Combină seturi pentru a-ți extinde joaca!  
Комбинируйте комплекты за по-интригуваща игра!  
Арvieno kompleksus, lai pilnveidotu savas rotaļas!

Kombineeri komplekte, et mängu laiendada!  
Derinkite rinkinius ir išplėskite žaidimą!





Rebuild  
the  
world™







Rebuild  
the  
world™



  
2x  
6202501

  
1x  
302401

  
2x  
300501

  
2x  
6059185

  
3x  
302301

  
1x  
306801

  
1x  
302201

  
2x  
4117070

  
8x  
6443061

  
2x  
6468818

  
1x  
6057517

  
1x  
6320357

  
1x  
4278422

  
1x  
6024495

  
2x  
4565387

  
1x  
4114084

  
1x  
6385114

  
1x  
6170776

  
3x  
6468819

  
1x  
4113916

  
1x  
4550324

  
5x  
6294227

  
2x  
4114319

  
3x  
4114309

  
1x  
4243824

  
4x  
4181134

  
1x  
4509897

  
1x  
302223

  
2x  
303223

  
4x  
302426

  
2x  
300526

  
4x  
403226

  
2x  
6272184

  
4x  
6253140

  
1x  
6269971

  
5x  
4107736

  
11x  
300328

  
2x  
4107762

  
1x  
302228

  
2x  
6385275

  
2x  
6023083

  
3x  
6468474

  
1x  
6253139

  
13x  
4566179

  
10x  
4106356

  
1x  
379528

  
1x  
303428

  
3x  
4279059



1x  
6434871



2x  
6253176



2x  
6172375



4x  
6347296



1x  
6368255



6x  
6195258



1x  
6336574



16x  
6389695



2x  
6343280



1x  
6470514



1x  
6468470



2x  
6310856



2x  
6462430



2x  
6462430



3x  
6468821



1x  
6382577



2x  
6315197



1x  
6252041



1x  
6252044



1x  
6382531



2x  
6252045



4x  
4212454



1x  
6281999



3x  
6209682



2x  
6310836



2x  
4626904



4x  
6167894



3x  
6114515



3x  
6114515



3x  
6114515



1x  
6347366



1x  
6335312



2x  
6252040



2x  
4216581



2x  
4211242



7x  
6468820



1x  
4221886



1x  
6336857



1x  
4211247



2x  
4211406



1x  
6216862



1x  
6216860



1x  
6216860



1x  
6216860



1x  
6126083



1x  
6055169



1x  
6251842



1x  
4550359



2x  
6204535



1x  
4538126



1x  
6097024



1x  
6097003



2x  
6097024



2x  
6097024



2x  
6097024



2x  
6186030



2x  
6186030

 [LEGO.com/service](https://www.LEGO.com/service)



YOU COULD **WIN**



Scan this QR code or go to **LEGO.COM/PRODUCTFEEDBACK** and give us your short feedback about this LEGO® set for a chance to win a cool LEGO prize.

Terms and Conditions apply\*

**EN: YOU COULD WIN.** Terms and Conditions apply\* **DE: Du könntest GEWINNEN.** Es gelten die Teilnahmebedingungen\* **FR: Tu pourrais GAGNER.** Des conditions s'appliquent\* **IT: Potresti VINCERE tu.** Termini e condizioni sono applicabili\* **ES: Puedes GANAR.** Aplican términos y condiciones\* **PT: Poderá GANHAR.** Aplicam-se termos e condições\* **ZH: 轻松获奖. 条款和条件适用\*** **PL: Szansa na WYGRANĄ.** Obowiązują warunki korzystania\* **CS: Máte šanci VYHRÁT.** Platí všeobecné smluvní podmínky\* **SK: Máte šancu VYHRAŤ.** Platia všeobecné zmluvné podmienky\* **HU: TE IS NYERHETSZ.** Felhasználási feltételek érvényesek\* **RO: Ai putea CÂȘTIGA.** Se aplică termeni și condiții\* **BG: Можете да СПЕЧЕЛИТЕ.** Има определени правила и условия\* **LV: Tu vari LAIMĒT.** Ir spēkā noteikumi un nosacījumi.\* **ET: Sul on võimalus VÕITA.** Kehtivad tingimused\* **LT: Jūs galite LAIMĖTI.** Taikomos sąlygos\*

\*[LEGO.com/productfeedback-terms](https://www.lego.com/productfeedback-terms)

LEGO and the LEGO logo are trademarks of the LEGO Group. ©2024 The LEGO Group.

© 2024 Mojang AB. All Rights Reserved. Minecraft, the Minecraft logo, the Mojang Studios logo and the Creeper logo are trademarks of the Microsoft group of companies.

6495801